

Latch, High Voltage Hall-Effect Switch IC

1 Product Description

The MT838X family is produced by BCD technology with both high performance and high reliability. The Hall IC internally includes an on-chip Hall voltage generator, a voltage regulator for operation with supply voltage of 3.8V to 60V, temperature compensation circuitry, small-signal amplifier, Hall IC with dynamic offset cancellation system, Schmitt trigger and an open collector output. It also includes an clamp diode at output and reversed power supply protection enhances the robustness of Hall IC.

The Hall IC designed to respond to alternating north and south poles. While the magnetic flux density(B) is larger than operating point (BOP), the output will be turned on (Low), the output is held until the magnetic flux density(B) is lower than releasing point (BRP), then turn off (High).

The MT838X family provides a variety of packages to customers: SOT-23/SOT-89B/SOT-23 (Thin Outline) for surface mount and flat TO-92 for through-hole mount. All packages are RoHS compliant.

2 Features

- AEC-Q100 Automotive Qualified MT838XAT & MT838XET
- BCD Technology
- Latch Switch
- 3.8~60V Operating Vcc Range
- -40°C~150°C Operating Temperature
- Package Option:
Flat TO-92
SOT-23
SOT-23 (Thin Outline)
SOT-89B
- Magnetic Sensitivity Option:
MT8381 (BOP=50Gs, BRP=-50Gs)
MT8282 (BOP=20Gs, BRP=-20Gs)
- Internal 10K pull-up resistor
- -20V Reversed Power Supply Protection
- Output Limiting Current Protection
- RoHS Compliant: (EU)2015/863

3 Product Overview of MT838X

Part No.	Description
MT838XA	Flat TO-92, bulk packaging (1000pcs/bag)
MT838XAT	SOT-23, tape & reel (3000pcs/bag)
MT838XET	SOT-23 (Thin Outline), tape & reel (3000pcs/bag)
MT838XBT	SOT-89B, tape & reel (1000pcs/bag)

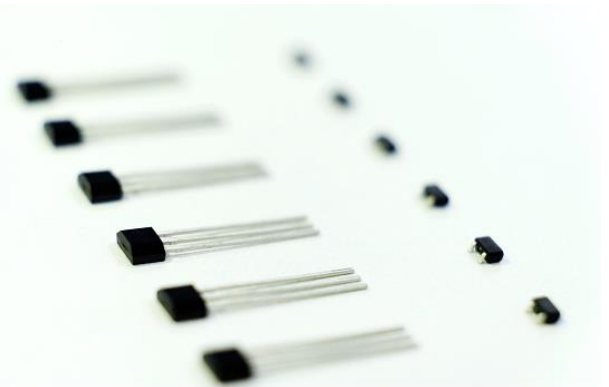

4 Applications

- Automotive, Home appliances,
- Industrial
- Speed Detection
- Magnetic Encoder
- Brushless DC Motor Communication

5. Pin Configuration and Functions

	Vcc	Out	GND
SOT-23	1	2	3
SOT-23 (Thin Outline)	1	2	3
SOT-89B	1	3	2
Flat TO-92	1	3	2
Description	Power	Internal Pull-up Resistor	Ground

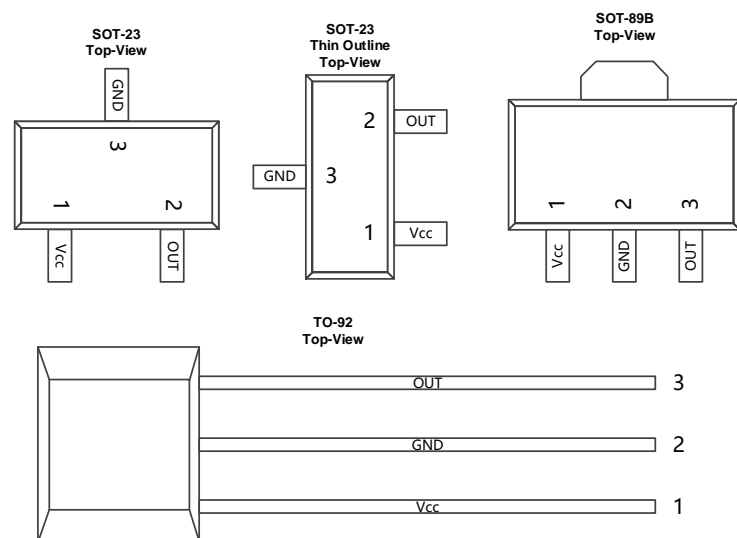

Figure.1 Pin Configuration & Functions

Table of Contents

1	Product Description.....	1
2	Features.....	1
3	Product Overview of MT838X	1
4	Applications.....	1
5	Pin Configuration and Functions.....	1
6	Definition of Switching Function.....	3
7	Functional Description.....	3
8	Feature Description.....	3
9	Functional Block Diagram.....	4
10	Electrical and Magnetic Characteristics.....	4
	10.1 Absolute Maximum Ratings.....	4
	10.2 Electrical Specifications.....	5
	10.3 Magnetic Characteristics.....	5
	10.4 ESD Ratings.....	5
	10.5 Characteristic Performance.....	6
	10.6 Typical Output Waveform.....	7
11	Package Material Information.....	8
	11.1 SOT-23 Package Information.....	8
	11.2 SOT-23 (Thin Outline) Package Information.....	9
	11.2 SOT-89B Package Information.....	10
	11.3 Flat TO-92 Package Information.....	11
12	Copy Rights and Disclaimer.....	12

Reversion History

1	Originally Version	
2	1.1 Version	Update MT8382 Series
3	1.2 Version	Remove Typical Application Circuit
4	1.3 Version	Update AEC-Q100 Automotive on MT831XAT Update RoHS compliant to (EU)2015/863
5	1.4 Version	Update AEC-Q100 Logo Update Copy Rights and Disclaimer
6	1.5 Version	Update AEC-Q100 Automotive on MT831XET
7	1.6 Version	Update the marking spec of SOT-23 & SOT-23 (Thin Outline)

6 Definition of Switching Function

Figure.2 & Figure.3 shows the device functionality and hysteresis

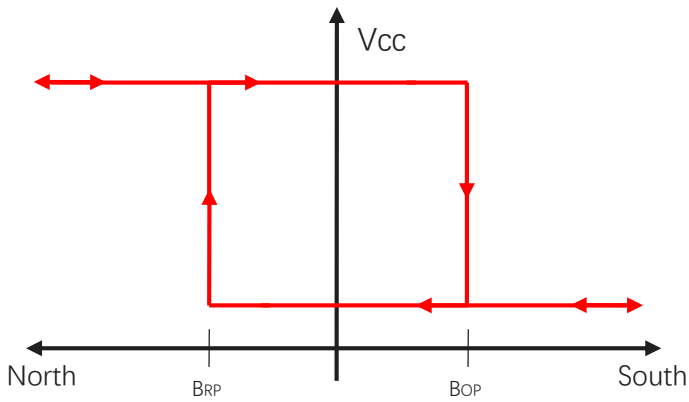

Figure.2 Switching Function of Flat TO-92 & SOT-89B & SOT-23 (Thin Outline)

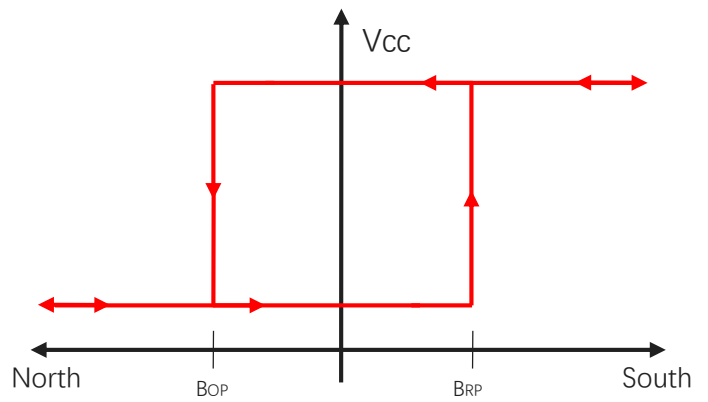

Figure.3 Switching Function of SOT-23

7 Function Description

B_{OP}: Operating Point, Magnetic flux density applied on the branded side of the package which turns the output driver ON ($V_{OUT}=Low$)

B_{RP}: Releasing Point, Magnetic flux density applied on the branded side of the package which turns the output driver OFF ($V_{OUT}=High$)

B_{HYST}: Hysteresis Window, $|B_{OP} - B_{RP}|$

Devices that have a lower magnetic threshold ($V_{OUT}=High$) detect magnets at a farther distance. Higher thresholds ($V_{OUT}=Low$) generally require a closer distance or larger magnet.

8 Feature Description

The MT838X device is sensitive to the magnetic field component that is perpendicular to the top of the package

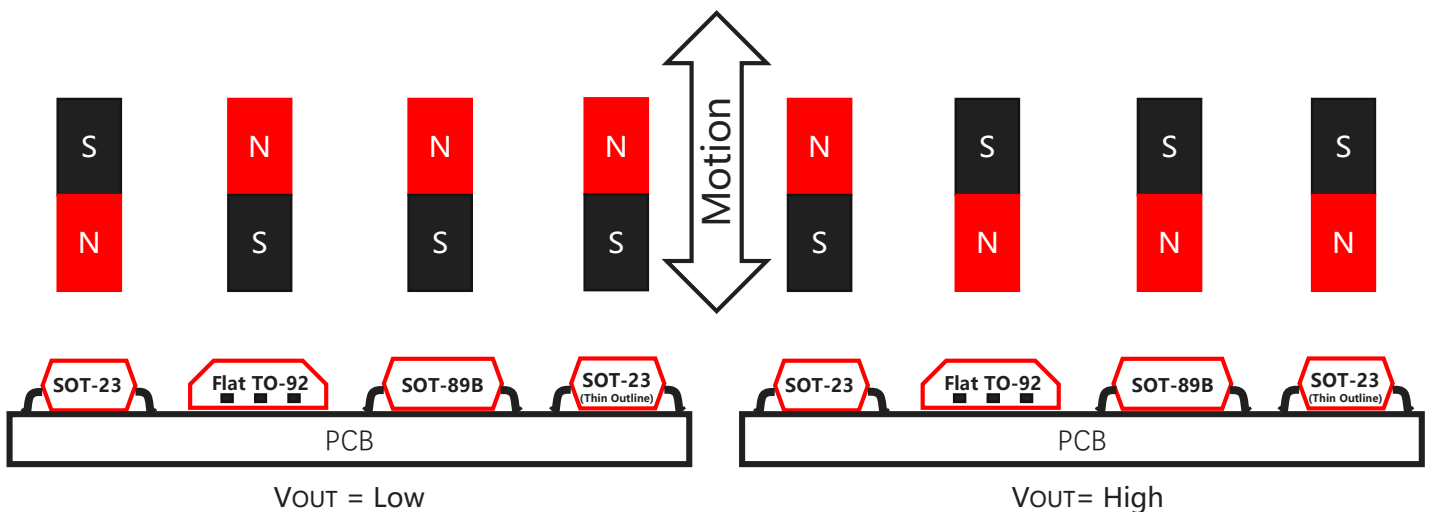

Figure.4 Flux Direction Polarity

9 Functional Block Diagram

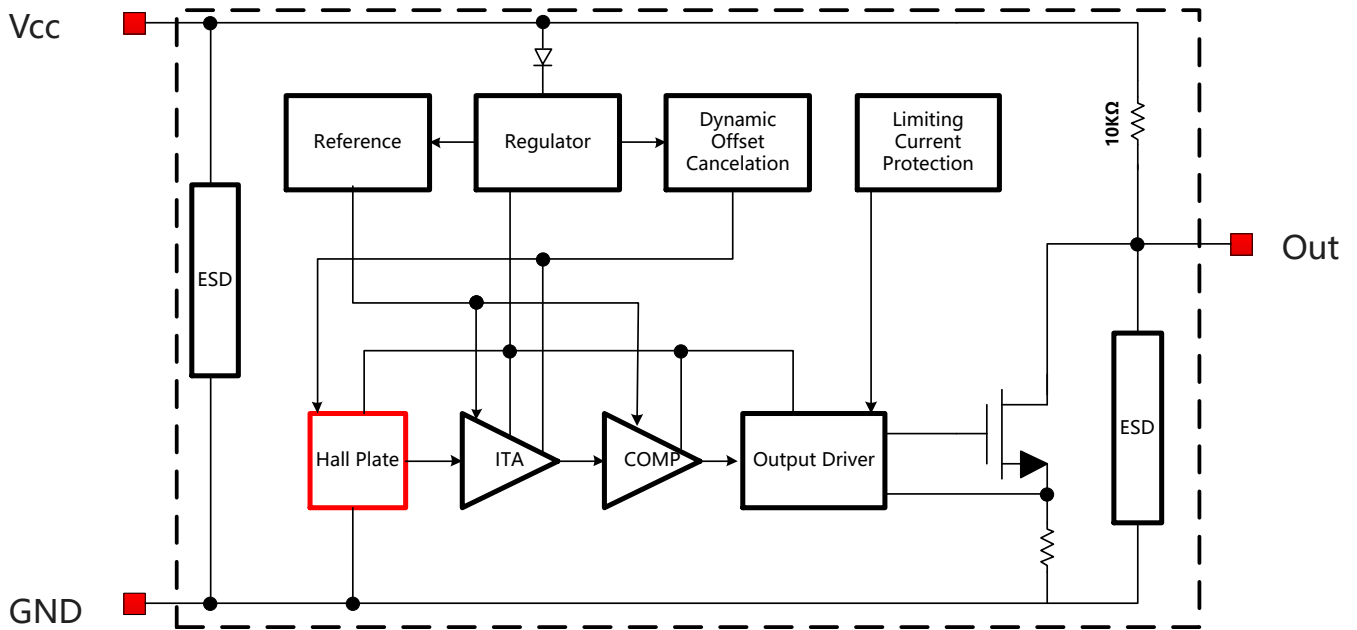

Figure.5 Functional Block Diagram

10 Electrical and Magnetic Characteristics

10.1 Absolute Maximum Ratings

Absolute maximum ratings are limited values to be applied individually, and beyond which the serviceability of the circuit may be impaired. Functional operability is not necessarily implied. Exposure to absolute maximum rating conditions for an extended period of time may affect device reliability.

Symbol	Parameters	Min	Max	Units
VCC	Supply Voltage	-	65	V
VRCC	Reverse Battery Voltage	-20	-	V
VOUT	Output Voltage	-	65	V
IOUT	Continuous Output Current	-	40	mA
TA	Operating Ambient Temperature	-40	150	°C
TS	Storage Temperature	-50	150	°C
TJ	Junction Temperature	-	165	°C
B	Magnetic Flux Density	No Limit		Gs

10.2 Electrical Specifications

At $T_A = -40 \sim 150 \text{ }^\circ\text{C}$, $V_{CC} = 3.8\text{V} \sim 60\text{V}$ (unless otherwise specified)

Symbol	Parameters	Test Condition	Min	Typ	Max	Unit
V _{CC}	Supply Voltage	Operating	3.8	-	60	V
I _{CC}	Supply Current	B < B _{RP}	-	4	6	mA
I _{OCP}	Short Circuit Protection Current	B > B _{OP} , V _{OUT} = V _{CC}	-	50	-	mA
V _{DSON}	Output Saturation Voltage	I _{OUT} = 15mA, B > B _{OP}	-	-	0.4	V
I _{OFF}	Output Leakage Current	V _{OUT} = 60V	-	-	10	uA
T _R	Output Rise Time	R _L = 1KOhm, C _L = 20pF	-	-	1.0	us
T _F	Output Fall Time	R _L = 1KOhm, C _L = 20pF	-	-	1.0	us
T _{PO}	Power on Time	dV _{CC} /dt > 5V/uS B > B _{OP(MAX)}	-	-	10	us
F _C	Chopping Frequency		-	800	-	KHz
F _S	Sampling Frequency		-	200	-	KHz
R _{PU}	Internal pull-up Resistor			10		KOhm
R _{TH}	Thermal Resistance of SOT-23		-	301	-	°C/W
	Thermal Resistance of SOT-23 (Thin Outline)		-	301	-	°C/W
	Thermal Resistance of Flat TO-92		-	230	-	°C/W
	Thermal Resistance of SOT-89B		-	230	-	°C/W

10.3 Magnetic Characteristics

At $V_{CC} = 3.8\text{V} \sim 60\text{V}$ (unless otherwise specified)

Part No.	Symbol	Min	Typ	Max	Unit
MT8381 Series	B _{OP} , T _A = 25°C	35	50	65	Gs
	B _{RP} , T _A = 25°C	-65	-50	-35	Gs
	B _{HYST} , T _A = 25°C	70	100	130	Gs
MT8382 Series	B _{OP} , T _A = 25°C	10	20	30	Gs
	B _{RP} , T _A = 25°C	-30	-20	-10	Gs
	B _{HYST} , T _A = 25°C	20	40	60	Gs

10.4 ESD Ratings

Symbol	Reference	Values	Unit
V _{ESD}	Human-body model (HBM)	AEC-Q100-002	Class II Grade
	Charged-device model (CDM)	AEC-Q100-011	Class C6 Grade

10.5 Characteristic Performance

At $V_{CC}=5V$

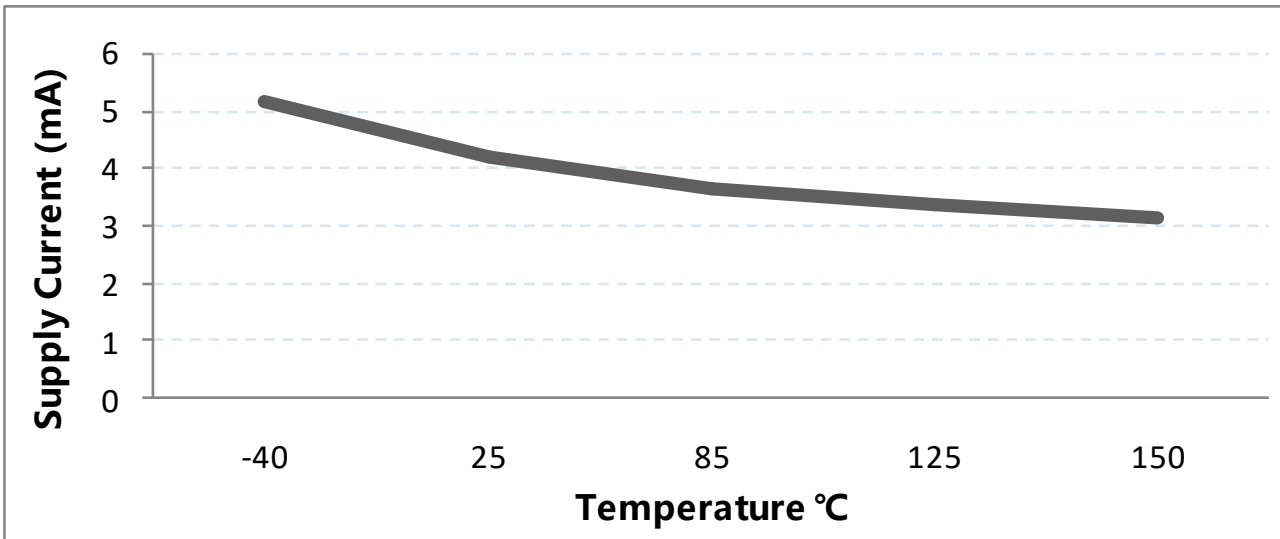

Figure.6 Supply Current vs. Temperature

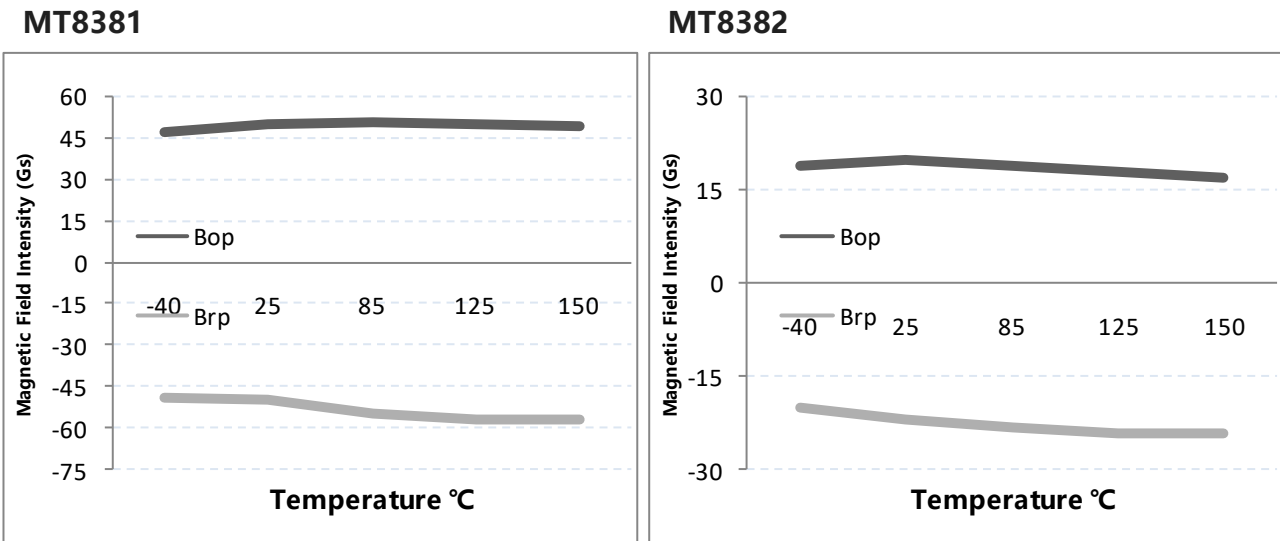

Figure.7 Magnetic Characteristics vs. Temperature (BOP & BRP)

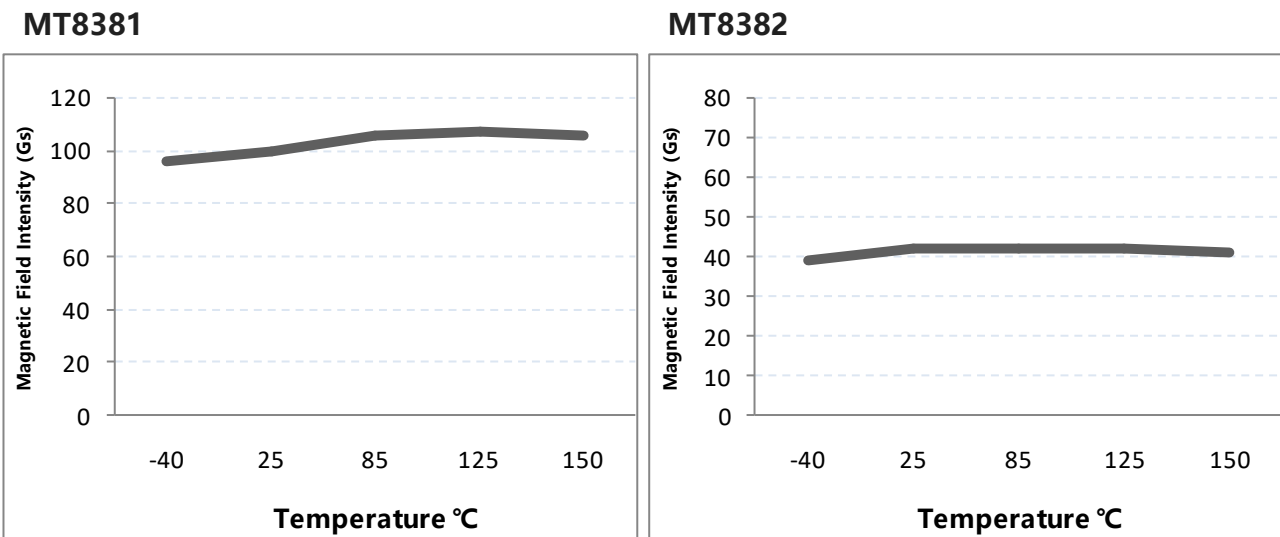

Figure.8 Magnetic Characteristics vs. Temperature (BHYST)

10.6 Typical Output Waveform

MT8381A as example

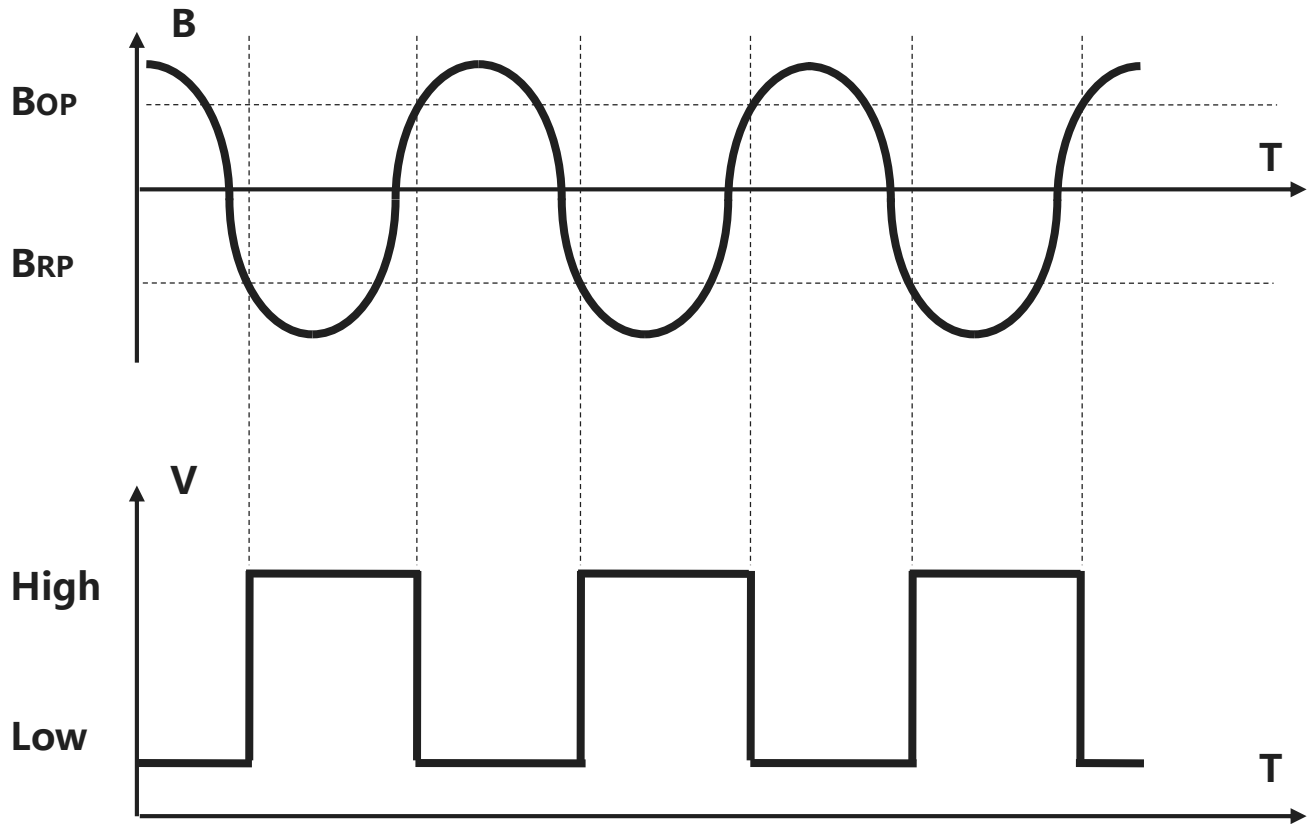

Figure.9 Digital Output vs. Magnetic Flux Density

11 Package Material Information (For Reference Only – Not for Tooling Use)

11.1 SOT-23 Package Information

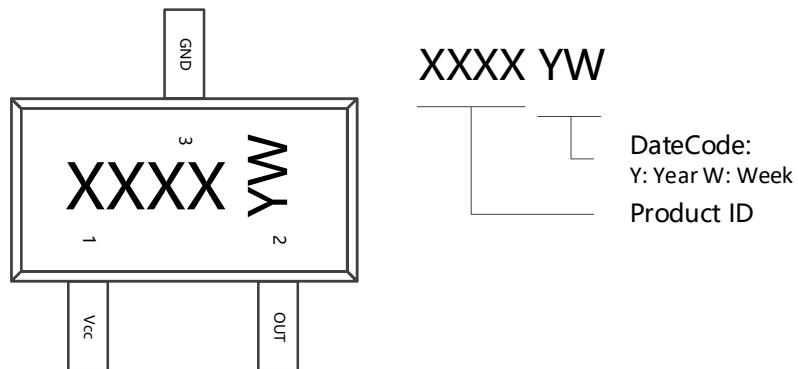

Figure.10 SOT-23 Chip Marking Spec

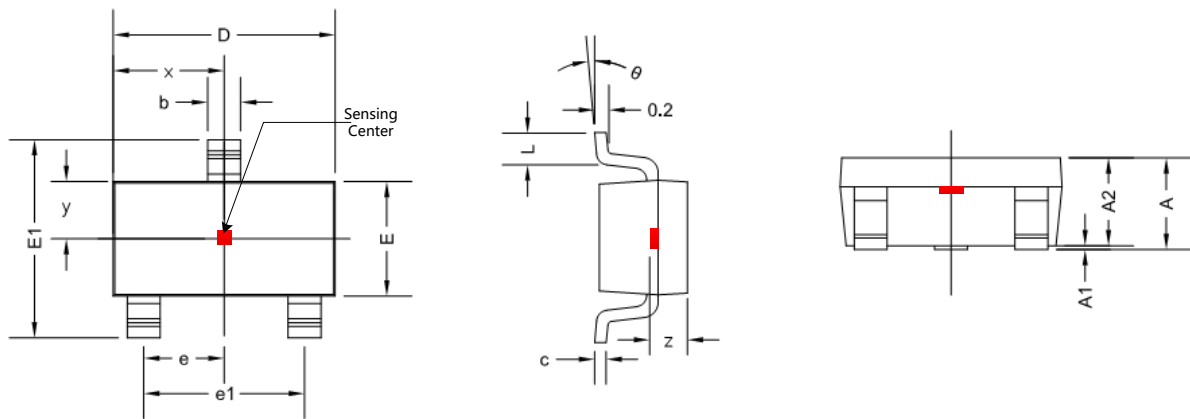

Figure.11 SOT-23 Package Drawing

Symbol	Dimensions in Millimeters		Dimensions in Inches	
	Min	Max	Min	Max
A	1.050	1.250	0.041	0.049
A1	0.000	0.100	0.000	0.004
A2	1.050	1.150	0.041	0.045
b	0.300	0.500	0.012	0.020
c	0.100	0.200	0.004	0.008
D	2.820	3.020	0.111	0.119
E	1.500	1.700	0.059	0.067
E1	2.650	2.950	0.104	0.116
e	0.950 TYP		0.037 TYP	
e1	1.800	2.000	0.071	0.079
L	0.300	0.600	0.012	0.024
θ	0 °	8 °	0 °	8 °
x	1.460 TYP		0.057 TYP	
y	0.800 TYP		0.032 TYP	
z	0.600 TYP		0.024 TYP	

11.2 SOT-23 (Thin Outline) Package Information

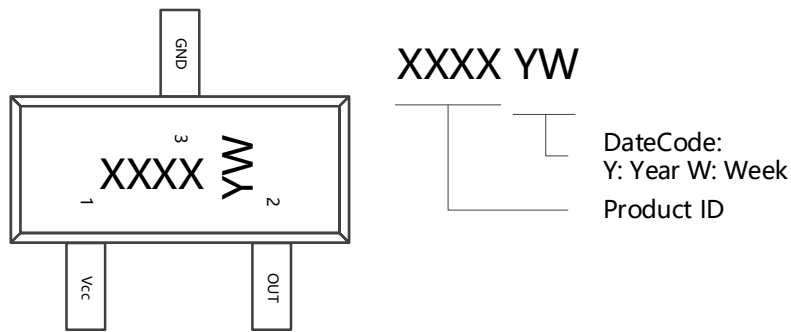

Figure.12 SOT-23 (Thin Outline) Chip Marking Spec

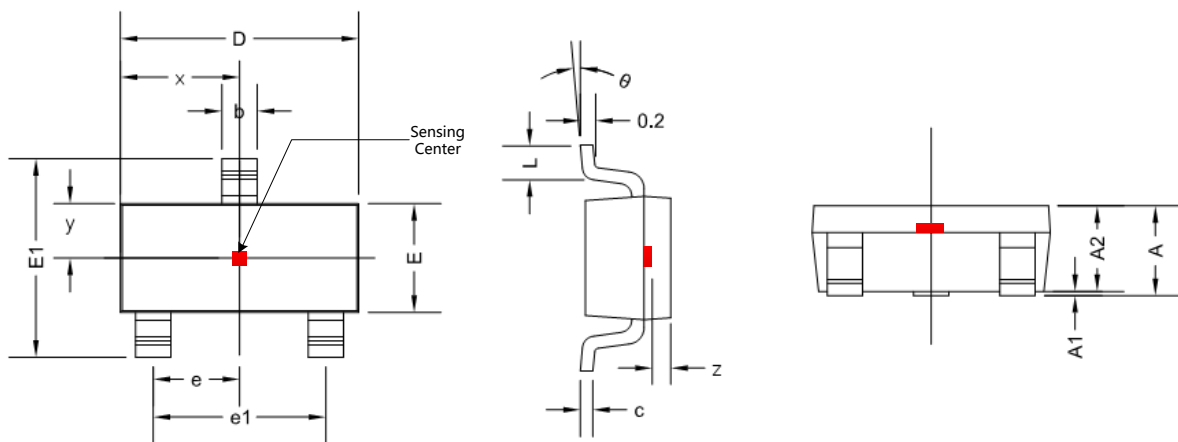

Figure.13 SOT-23 (Thin Outline) Package Drawing

Symbol	Dimensions in Millimeters		Dimensions in Inches	
	Min	Max	Min	Max
A	0.900	1.150	0.035	0.045
A1	0.000	0.100	0.000	0.004
A2	0.900	1.050	0.035	0.041
b	0.300	0.500	0.012	0.020
c	0.080	0.150	0.003	0.006
D	2.800	3.000	0.110	0.118
E	1.200	1.400	0.047	0.055
E1	2.250	2.550	0.089	0.100
e	0.950 TYP		0.037 TYP	
e1	1.800	2.000	0.071	0.079
L	0.550 REF		0.022 REF	
L1	0.300	0.500	0.012	0.020
θ	0 °	8 °	0 °	8 °
x	1.460 TYP		0.057 TYP	
y	0.650 TYP		0.026 TYP	
z	0.500 TYP		0.020 TYP	

11.3 SOT-89B Package Information

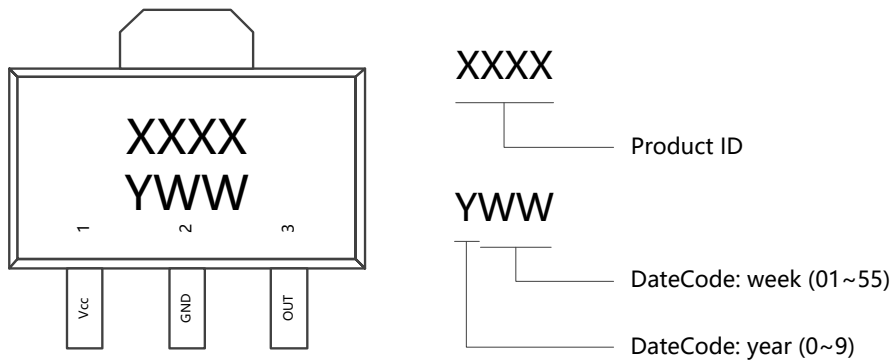

Figure.14 SOT-89B Chip Marking Spec

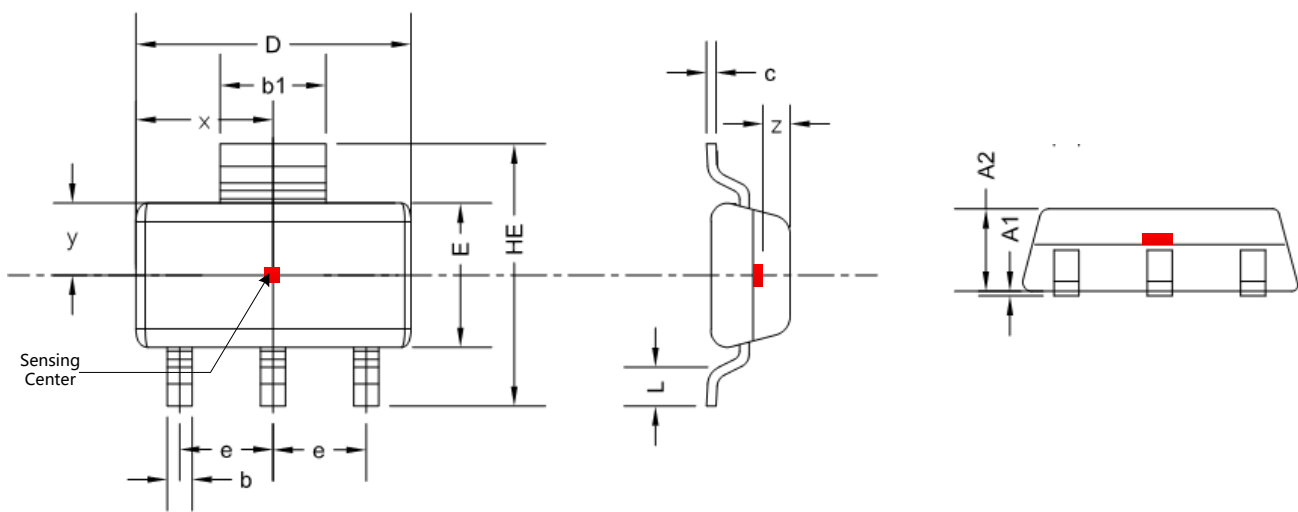

Figure.15 SOT-89B Package Drawing

Symbol	Dimensions in Millimeters		Dimensions in Inches	
	Min	Max	Min	Max
A2	1.220	1.420	0.048	0.056
A1	0.000	0.100	0.000	0.004
b	0.300	0.500	0.012	0.020
c	0.052	0.252	0.002	0.010
D	4.400	4.600	0.173	0.181
b1	1.600	1.800	0.063	0.071
E	2.400	2.600	0.094	0.102
HE	4.000	4.400	0.157	0.173
e	1.400	1.600	0.055	0.063
L	0.350	0.550	0.014	0.022
x	2.250 TYP		0.089 TYP	
y	1.250 TYP		0.049 TYP	
z	0.300 TYP		0.012 TYP	

11.4 Flat TO-92 Package Information

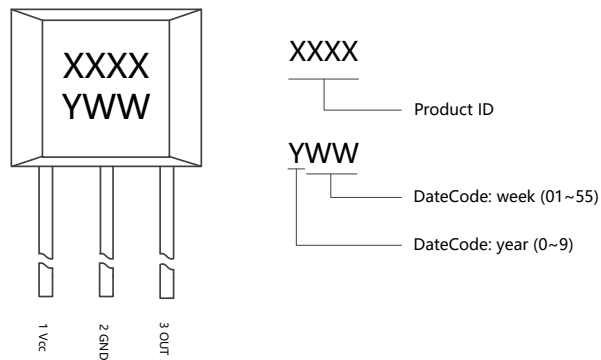

Figure.16 Flat TO-92 Chip Marking Spec

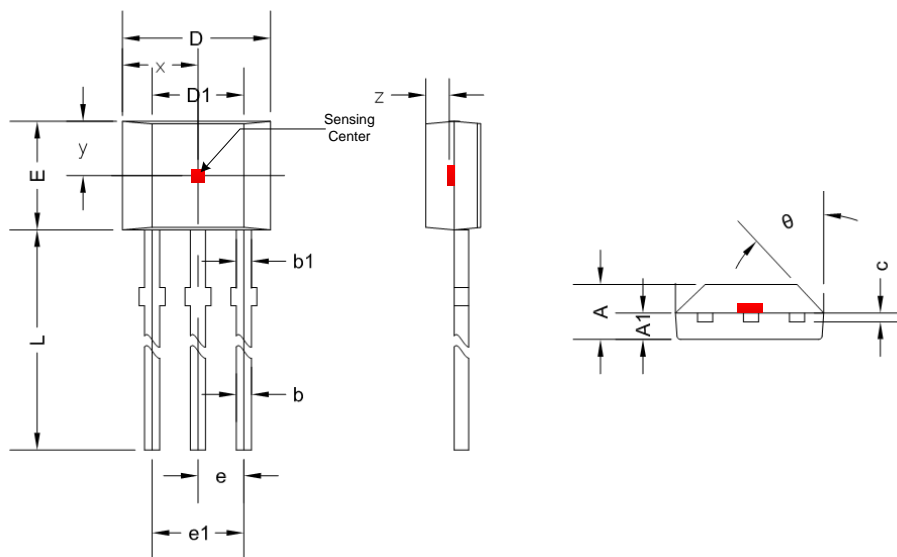

Figure.17 Flat TO-92 Package Drawing

Symbol	Dimensions in Millimeters		Dimensions in Inches	
	Min	Max	Min	Max
A	1.420	1.620	0.056	0.064
A1	0.660	0.860	0.026	0.034
b	0.350	0.480	0.013	0.019
b1	0.400	0.510	0.016	0.020
c	0.330	0.510	0.013	0.020
D	3.900	4.100	0.154	0.161
D1	2.280	2.680	0.090	0.106
E	3.050	3.250	0.120	0.128
e	1.270 TYP		0.050 TYP	
e1	2.440	2.640	0.096	0.104
L	14.350	14.750	0.565	0.581
θ	45 ° TYP		45 ° TYP	
x	2.025 TYP		0.080 TYP	
y	1.545 TYP		0.061 TYP	
z	0.500 TYP		0.020 TYP	

12 Copy Rights and Disclaimer

1. This document may not be reproduced or duplicated, in any form, in whole or in part without prior written consent of MagnTek . Copyrights © 2019, MagnTek Incorporated.
2. MagnTek reserves the right to make changes to the information published in this document at anytime without notice.
3. MagnTek' s products are limited for use in normal commercial applications. MagnTek' s products are not to be used in any device or system, including but not limited to medical life support equipment and system.

For the latest version of this document, please visit our website: www.magntek.com.cn