

CJ6206 Series

■ INTRODUCTION

The CJ6206 series are a group of positive voltage regulators manufactured by CMOS technologies with high ripple rejection, low power consumption and low dropout voltage, which can prolong battery life in portable electronics. The CJ6206 series work with low-ESR ceramic capacitors, reducing the amount of board space necessary for power applications. The CJ6206 series consume less than 0.1uA in shutdown mode and have fast turn-on time less than 50us. The series are very suitable for the battery-powered equipments, such as RF applications and other systems requiring a quiet voltage source.

■ APPLICATIONS

- Cellular and Smart Phones
- Laptop, Palmtops and PDA
- Digital Still and Video Cameras

■ BLOCK DIAGRAM

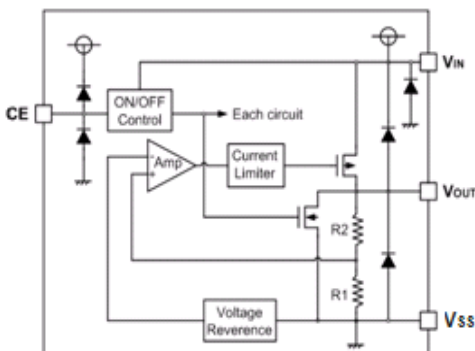

■ FEATURES

- Low Dropout Voltage: 150mV@150mA
- Low Quiescent Current: 5uA
- High Ripple Rejection: 65dB@1kHz
- Excellent Line and Load Transient Response
- Operating Voltage: 2.0V~7.0V
- Output Voltage: 1.2 ~ 5.0V
- High Accuracy: ±2% (Typ.)
- Built-in Current Limiter, Short-Circuit Protection
- TTL- Logic-Controlled Shutdown Input

- MP3, MP4 Player
- Radio control systems
- Battery-Powered Equipment

■ ORDER INFORMATION

CJ6206 ①②③④

DESIGNATOR	SYMBOL	DESCRIPTION
①	A	Standard
	B	With Shutdown Function
②③	Integer	Output Voltage e.g. 1.8V=②:1, ③:8
④	N	Package:SOT-23
	M	Package:SOT-23-3L/5L
	P/PT	Package:SOT-89-3L
	F	Package:DFNWB1x1-4L

Pin Configuration

(Top view)

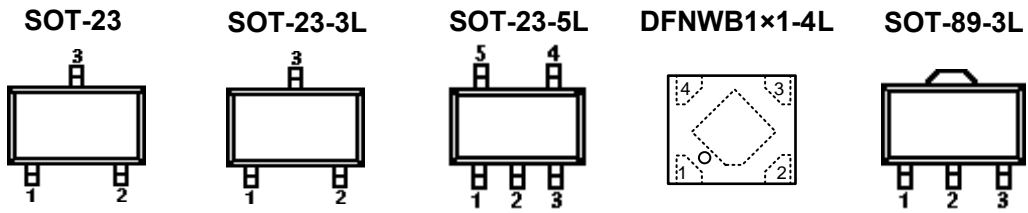

PIN NUMBER				PIN NAME	FUNCTION
SOT-23	SOT-23-3L	SOT-89-3L			
N	M	P	PT		
1	1	1	2	V_{SS}	Ground
2	2	3	1	V_{OUT}	Output
3	3	2	3	V_{IN}	Power input

SOT-23-5L

PIN NUMBER	SYMBOL	FUNCTION
1	V_{IN}	Power Input Pin
2	V_{SS}	Ground
3	CE	Chip Enable Pin
4	NC	No Connection
5	V_{OUT}	Output Pin

DFNWB1x1-4L

PIN NUMBER	SYMBOL	FUNCTION
F		
1	V_{OUT}	Output Pin
2	V_{SS}	Ground
3	CE	Chip Enable Pin
4	V_{IN}	Power Input Pin

Electrical Characteristics

■ ABSOLUTE MAXIMUM RATINGS

(Unless otherwise specified, Ta=25°C)

PARAMETER		SYMBOL	RATINGS	UNITS
Input Voltage		V _{IN}	V _{SS} -0.3~V _{SS} +8	V
Output Current		I _{OUT}	600	mA
Output Voltage		V _{OUT}	V _{SS} -0.3~V _{IN} +0.3	V
Power Dissipation	SOT-23	Pd	0.3	W
	SOT-23-3L/SOT-23-5L		0.4	W
	DFNWB1×1-4L		0.3	W
	SOT-89-3L		0.6	W
Operating Ambient Temperature		T _A	-40~+85	°C
Operating Junction Temperature		T _j	-40~+125	°C
Storage Temperature		T _{stg}	-40~+125	°C
Soldering Temperature & Time		T _{solder}	260°C, 10s	

■ ELECTRICAL CHARACTERISTICS

(V_{IN}=V_{OUT}+1V, C_{IN}=C_{OUT}=1μF, Ta=25°C, unless otherwise specified)

PARAMETER	SYMBOL	CONDITIONS	MIN.	TYP.	MAX.	UNITS
Output Voltage	V _{OUT} (E) (Note 2)	I _{OUT} =1mA	V _{OUT} *0.98	V _{OUT}	V _{OUT} *1.02	V
Supply Current	I _{SS}	I _{OUT} =0		5	10	μA
Standby Current	I _{STBY}	CE = V _{SS}			0.1	μA
Output Current	I _{OUT}	—	300			mA
Dropout Voltage (Note 3)	V _{dif}	I _{OUT} =150mA V _{OUT} ≥3.0V		150		mV
Load Regulation	ΔV _{OUT}	V _{IN} = V _{OUT} +1V, 1mA≤I _{OUT} ≤100mA		10		mV
Line Regulation	$\frac{\Delta V_{OUT}}{V_{OUT} \times \Delta V_{IN}}$	I _{OUT} =10mA V _{OUT} +1V≤V _{IN} ≤6V		0.01	0.2	%/V
Output Voltage Temperature Characteristics	$\frac{\Delta V_{OUT}}{\Delta T \times V_{OUT}}$	I _{OUT} =10mA -40≤T≤+85		100		ppm
Short Current	I _{Short}	V _{OUT} =V _{SS}		50		mA
Input Voltage	V _{IN}	—	2.0		7.0	V
Power Supply Rejection Rate	1kHz	PSRR	I _{OUT} =50mA	65		dB
	10kHz			50		
CE "High" Voltage	V _{CE} "H"		1.5		V _{IN}	V
CE "Low" Voltage	V _{CE} "L"				0.3	V

NOTE:

- V_{OUT}: Specified Output Voltage.
- V_{OUT} (E) : Effective Output Voltage (Ie. The Output Voltage When V_{IN} = (V_{OUT} +1.0V) And Maintain A Certain I_{OUT} Value).
- V_{dif}: The Difference Of Output Voltage And Input Voltage When Input Voltage Is Decreased Gradually Till Output Voltage Equals To 98% Of V_{OUT} (E).

Typical Characteristics

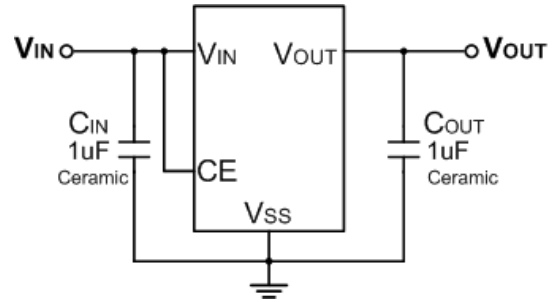
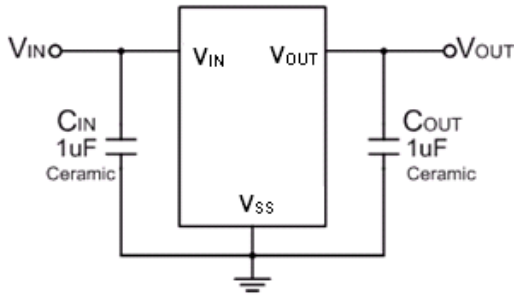

■ TYPICAL PERFORMANCE CHARACTERISTICS

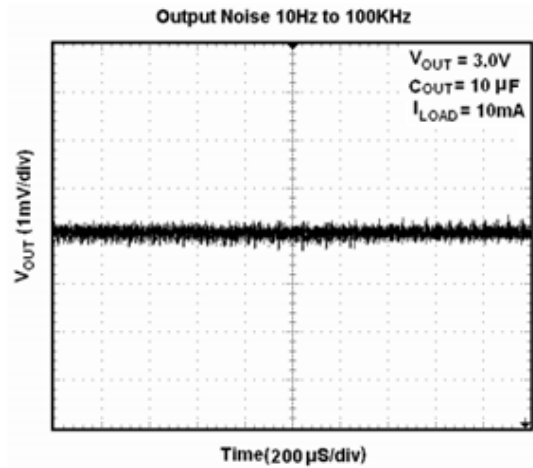
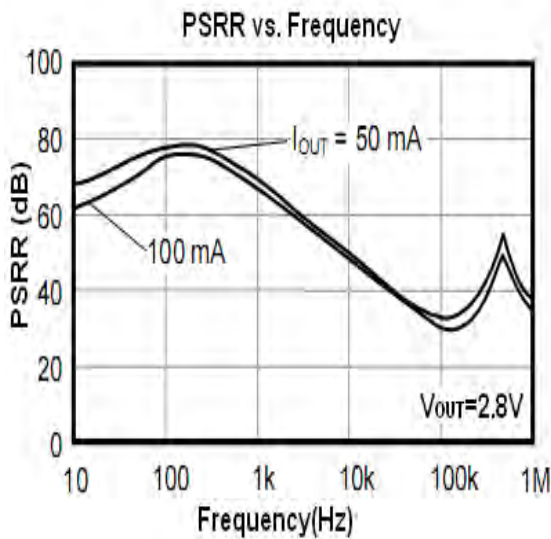
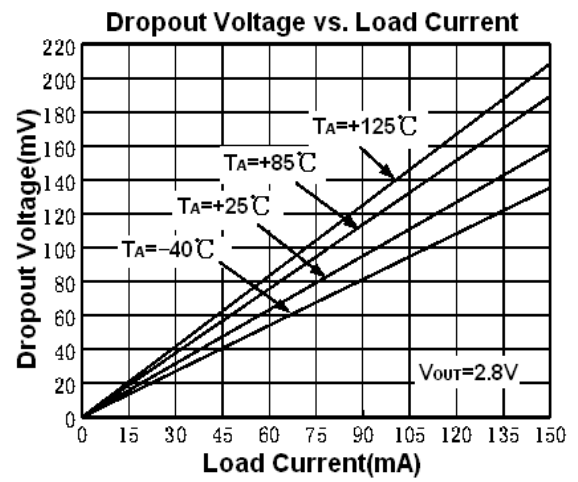
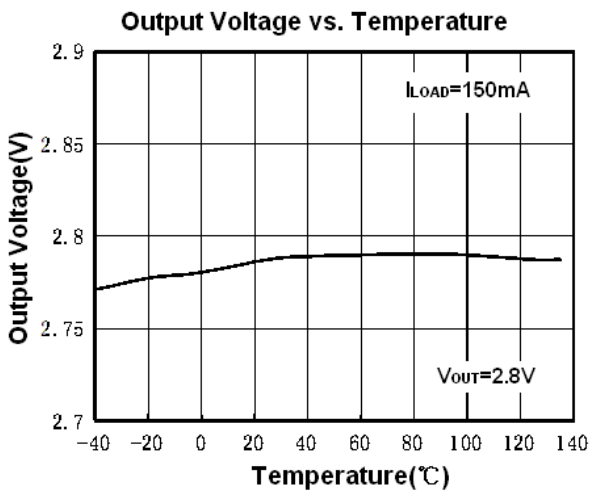

Typical Characteristics

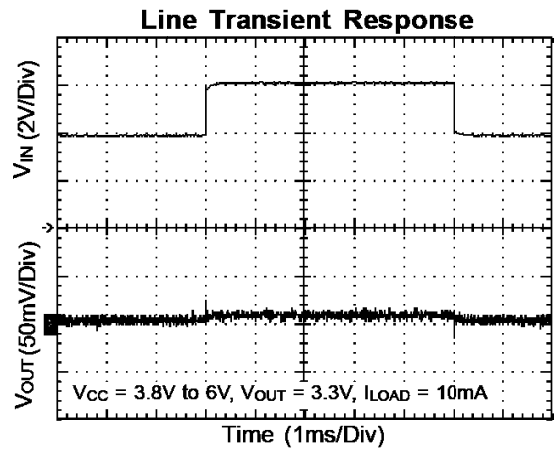
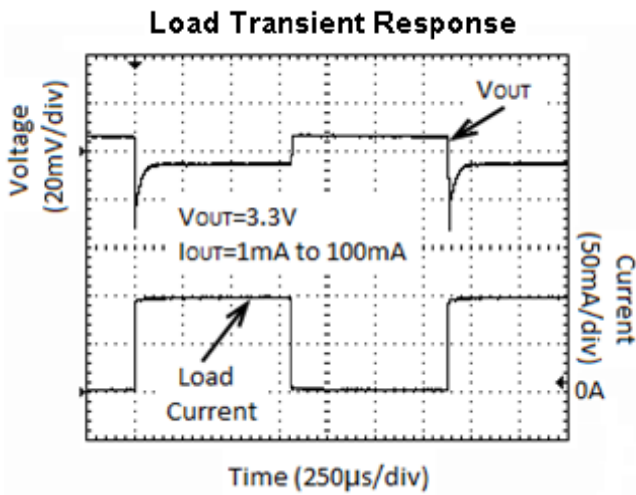
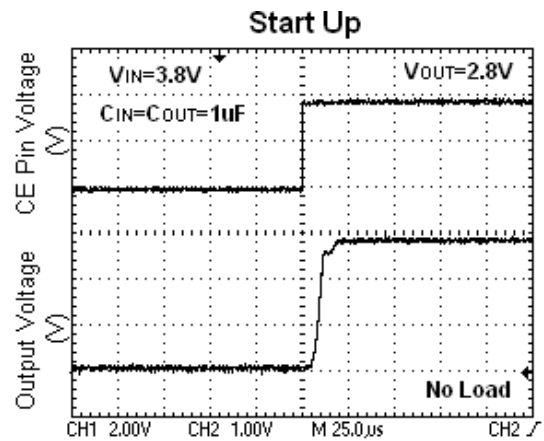
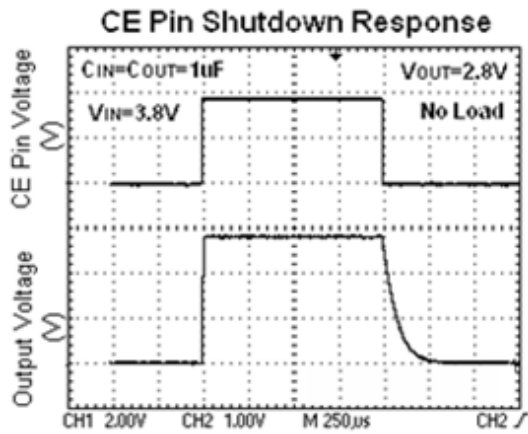

SOT-23 Package Outline Dimensions

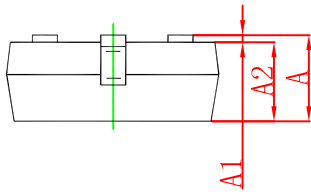
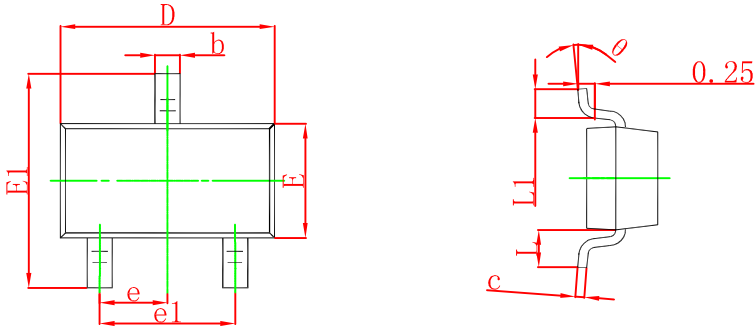

Symbol	Dimensions In Millimeters		Dimensions In Inches	
	Min.	Max.	Min.	Max.
A	0.900	1.150	0.035	0.045
A1	0.000	0.100	0.000	0.004
A2	0.900	1.050	0.035	0.041
b	0.300	0.500	0.012	0.020
c	0.080	0.150	0.003	0.006
D	2.800	3.000	0.110	0.118
E	1.200	1.400	0.047	0.055
E1	2.250	2.550	0.089	0.100
e	0.950 TYP.		0.037 TYP.	
e1	1.800	2.000	0.071	0.079
L	0.550 REF.		0.022 REF.	
L1	0.300	0.500	0.012	0.020
θ	0°	8°	0°	8°

SOT-23 Suggested Pad Layout

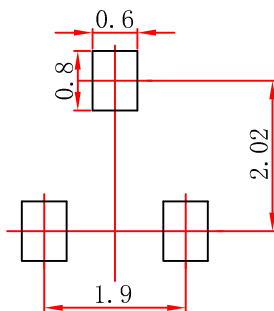

Note:

1. Controlling dimension: in millimeters.
2. General tolerance: ± 0.05 mm.
3. The pad layout is for reference purposes only.

SOT-23-3L Package Outline Dimensions

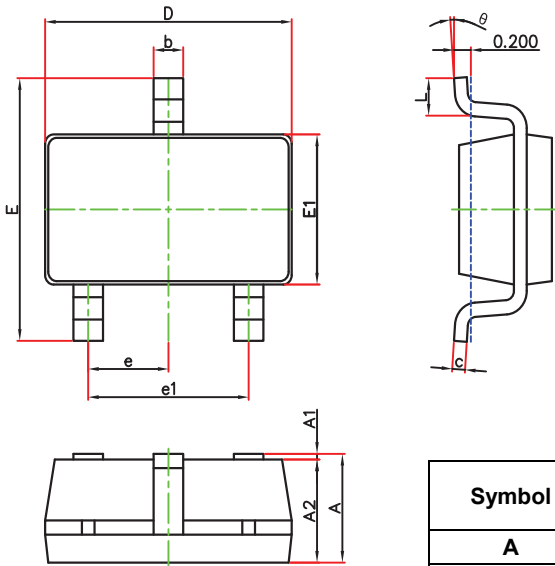

Symbol	Dimensions In Millimeters		Dimensions In Inches	
	Min.	Max.	Min.	Max.
A	1.050	1.250	0.041	0.049
A1	0.000	0.100	0.000	0.004
A2	1.050	1.150	0.041	0.045
b	0.300	0.500	0.012	0.020
c	0.100	0.200	0.004	0.008
D	2.820	3.020	0.111	0.119
E	2.650	2.950	0.104	0.116
E1	1.500	1.700	0.059	0.067
e	0.950(BSC)		0.037(BSC)	
e1	1.800	2.000	0.071	0.079
L	0.300	0.600	0.012	0.024
theta	0°	8°	0°	8°

SOT-23-3L Suggested Pad Layout

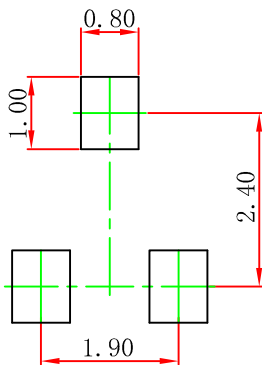

- Note:
1. Controlling dimension: in millimeters.
 2. General tolerance: $\pm 0.05\text{mm}$.
 3. The pad layout is for reference purposes only.

SOT-23-5L Package Outline Dimensions

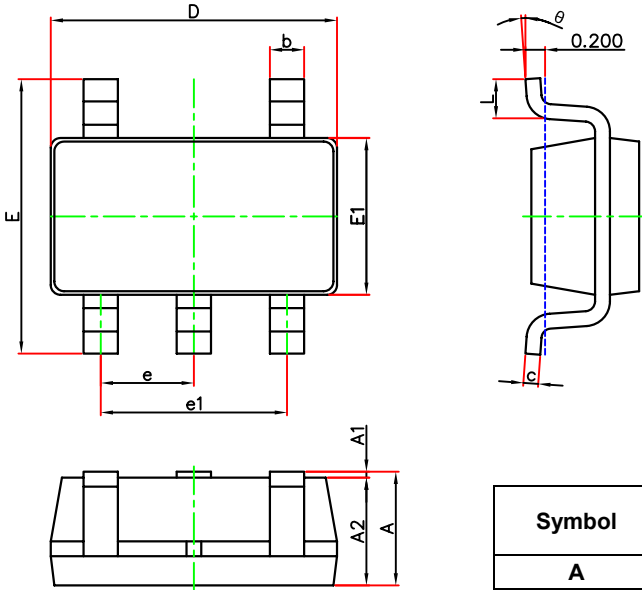

Symbol	Dimensions In Millimeters		Dimensions In Inches	
	Min.	Max.	Min.	Max.
A	1.050	1.250	0.041	0.049
A1	0.000	0.100	0.000	0.004
A2	1.050	1.150	0.041	0.045
b	0.300	0.500	0.012	0.020
c	0.100	0.200	0.004	0.008
D	2.820	3.020	0.111	0.119
E	2.650	2.950	0.104	0.116
E1	1.500	1.700	0.059	0.067
e	0.950(BSC)		0.037(BSC)	
e1	1.800	2.000	0.071	0.079
L	0.300	0.600	0.012	0.024
θ	0°	8°	0°	8°

SOT-23-5L Suggested Pad Layout

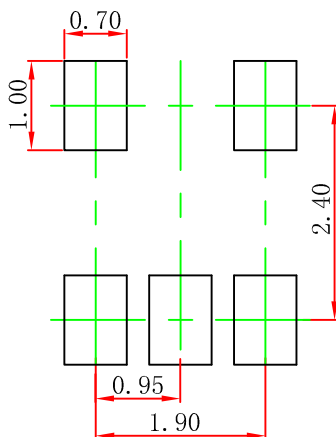

Note:

1. Controlling dimension: in millimeters.
2. General tolerance: $\pm 0.05\text{mm}$.
3. The pad layout is for reference purposes only.

SOT-89-3L Package Outline Dimensions

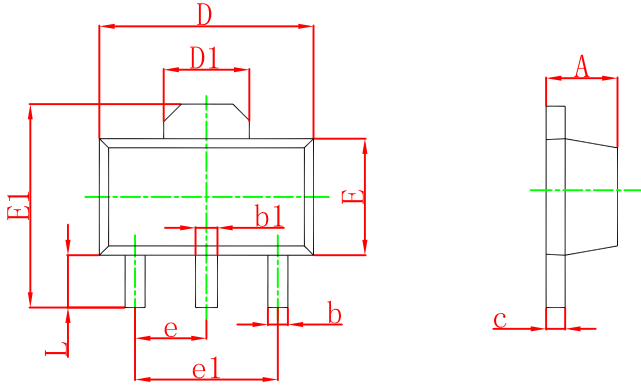

Symbol	Dimensions In Millimeters		Dimensions In Inches	
	Min.	Max.	Min.	Max.
A	1.400	1.600	0.055	0.063
b	0.320	0.520	0.013	0.197
b1	0.400	0.580	0.016	0.023
c	0.350	0.440	0.014	0.017
D	4.400	4.600	0.173	0.181
D1	1.550 REF		0.061 REF	
E	2.300	2.600	0.091	0.102
E1	3.940	4.250	0.155	0.167
e	1.500 TYP		0.060 TYP	
e1	3.000 TYP		0.118 TYP	
L	0.900	1.200	0.035	0.047

SOT-89-3L Suggested Pad Layout

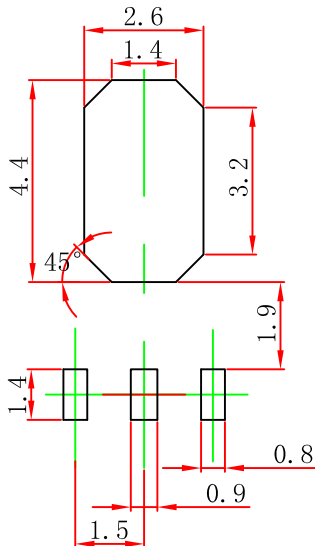

- Note:
1. Controlling dimension: in millimeters.
 2. General tolerance: $\pm 0.05\text{mm}$.
 3. The pad layout is for reference purposes only.

