

Omni-polar, Low Power, 360 Degree Switch IC

1 Product Description

The MT613X family is produced with monolithic technology, which builds AMR sensor & ASIC on one chip. The IC internally includes a Wheatstone bridge with magnetic film, a current regulator for operating with supply voltage from 1.65V to 5.0V, a sleep/awake logic for low power consumption requirement, small signal amplifier and Schmitt trigger comparator with dynamic offset cancellation, and an output driver with push pull output.

When combined with a magnet, it becomes a non-contact switch with low power consumption, high sensitivity and high reliability. All directions of horizontal magnetic field parallel to the electrode of the package can be detected by an arbitrary polarity.

The MT613X family provide SOT-23 for surface mount, RoHS compliant.

2 Features

- Monolithic Technology
- 360 Degree AMR (Anisotropic Magneto Resistance)
- Omni-polar Switch
- 1.65~5.0V Operating Vcc Range
- -40°C~125°C Operating Temperature
- Package Option:
SOT-23
- Magnetic Sensitivity Option:
BOP=±18Gs, BRP=±13Gs
- Push Pull & Open Drain Output Option:
MT6131 & MT6132: Push Pull
MT6133 & MT6135: Open Drain
- Operation Frequency Option:
MT6131 & MT6133: 20Hz
MT6132 & MT6135: 1KHz
- Low Power Consumption
- RoHS Compliant: (EU)2015/863

3 Product Overview of MT613X

| Part No. | Description |
|----------|-----------------------------------|
| MT613XAT | SOT-23, tape & reel (3000pcs/bag) |

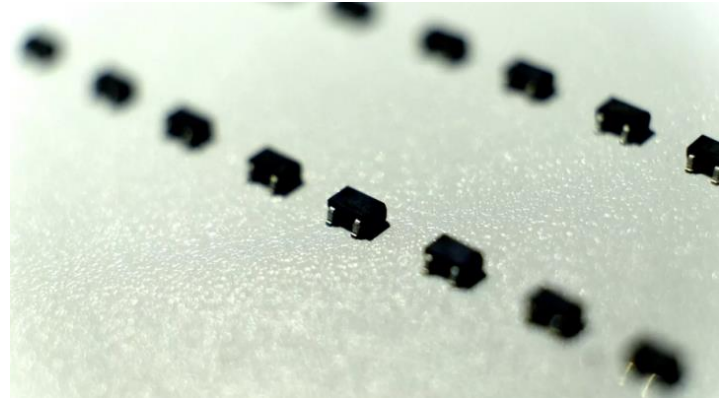

4 Application

- Home appliances, Industrial
- Position Detection
- Proximity Switch
- Smart Meter
- Speed Detection
- Handheld Device
- Consumer Device

5. Pin Configuration and Functions

| | Vcc | Out | GND |
|-------------|-------|--------------------------------------|--------|
| SOT-23 | 1 | 2 | 3 |
| Description | Power | Output Push Pull or Open Drain | Ground |

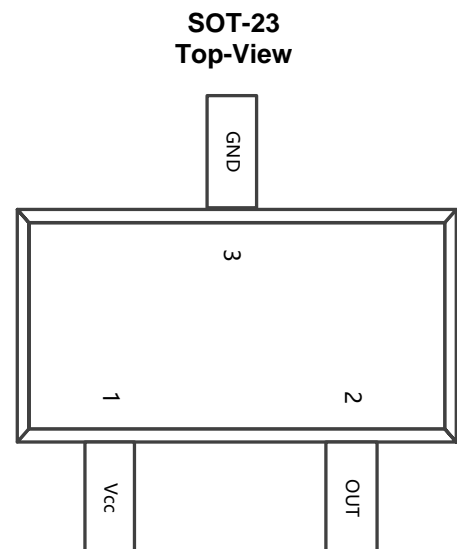

Figure.1 Pin Configuration & Functions

Table of Contents

| | | |
|----|--|----|
| 1 | Product Description..... | 1 |
| 2 | Features..... | 1 |
| 3 | Product Overview of MT613X | 1 |
| 4 | Applications..... | 1 |
| 5 | Pin Configuration and Functions..... | 1 |
| 6 | Definition of Switching Function..... | 3 |
| 7 | Function Description..... | 3 |
| 8 | Feature Description..... | 3 |
| 9 | Functional Block Diagram..... | 4 |
| 10 | Electrical and Magnetic Characteristics..... | 5 |
| | 10.1 Absolute Maximum Ratings..... | 5 |
| | 10.2 Electrical Specifications..... | 5 |
| | 10.3 Magnetic Characteristics..... | 6 |
| | 10.4 ESD Ratings..... | 6 |
| | 10.5 Characteristic Performance..... | 6 |
| | 10.6 Typical Output Waveform..... | 7 |
| 11 | Typical Application Circuit..... | 7 |
| 12 | Power on Output Waveform..... | 8 |
| 13 | Package Material Information..... | 9 |
| | 13.1 SOT-23 Package Information..... | 9 |
| 14 | Copy Rights and Disclaimer..... | 10 |

Reversion History

| | | |
|---|--------------------|--|
| 1 | Originally Version | |
| 2 | 1.1 Version | Update supply current Update the marking spec of SOT-23 |

6 Definition of Switching Function

Figure.2 shows the device functionality and hysteresis

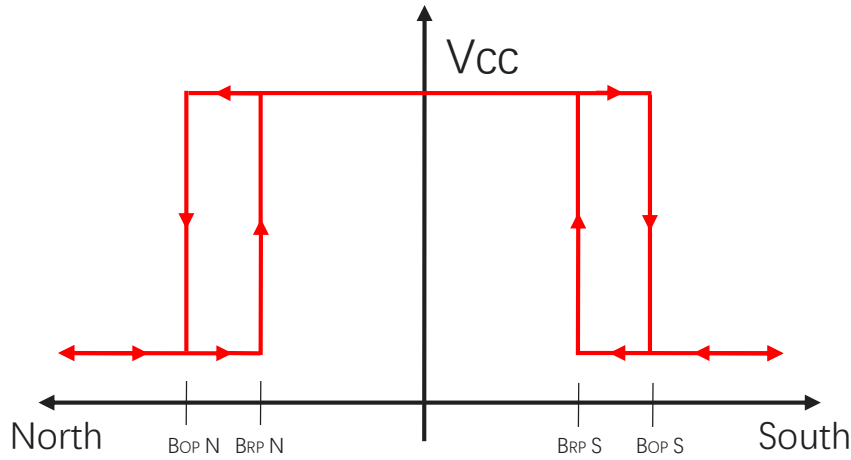

Figure.2 Omni-polar Switching Function

7 Function Description

B_{OP}: Operating Point, Magnetic flux density applied on the branded side of the package which turns the output driver ON ($V_{OUT}=Low$)

B_{RP}: Releasing Point, Magnetic flux density applied on the branded side of the package which turns the output driver OFF ($V_{OUT}=High$)

B_{HYST}: Hysteresis Window, $|B_{OP} - B_{RP}|$

8 Feature Description

The MT613X series is sensitive to the magnetic field that is parallel to the package (X & Y axis). To operate the MR switch, the magnetic field should be applied to the sensor parallel to the package. MT613X series detect the magnetic field in any parallel direction, but it does not respond to magnetic field in the vertical direction.

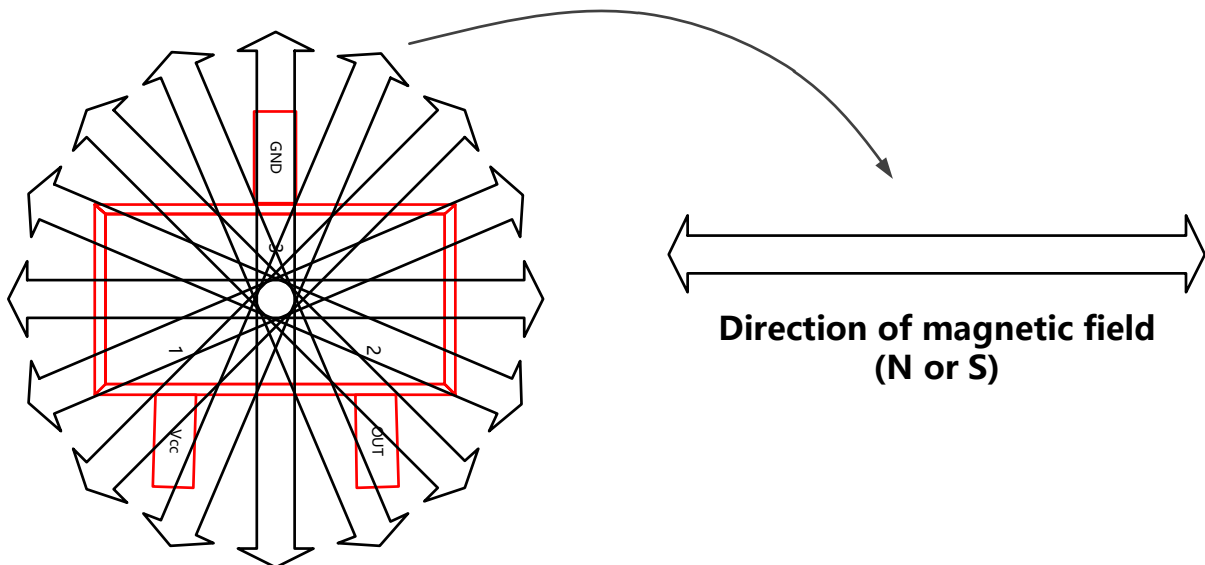

Figure.3 Detection of magnetic field

9 Functional Block Diagram

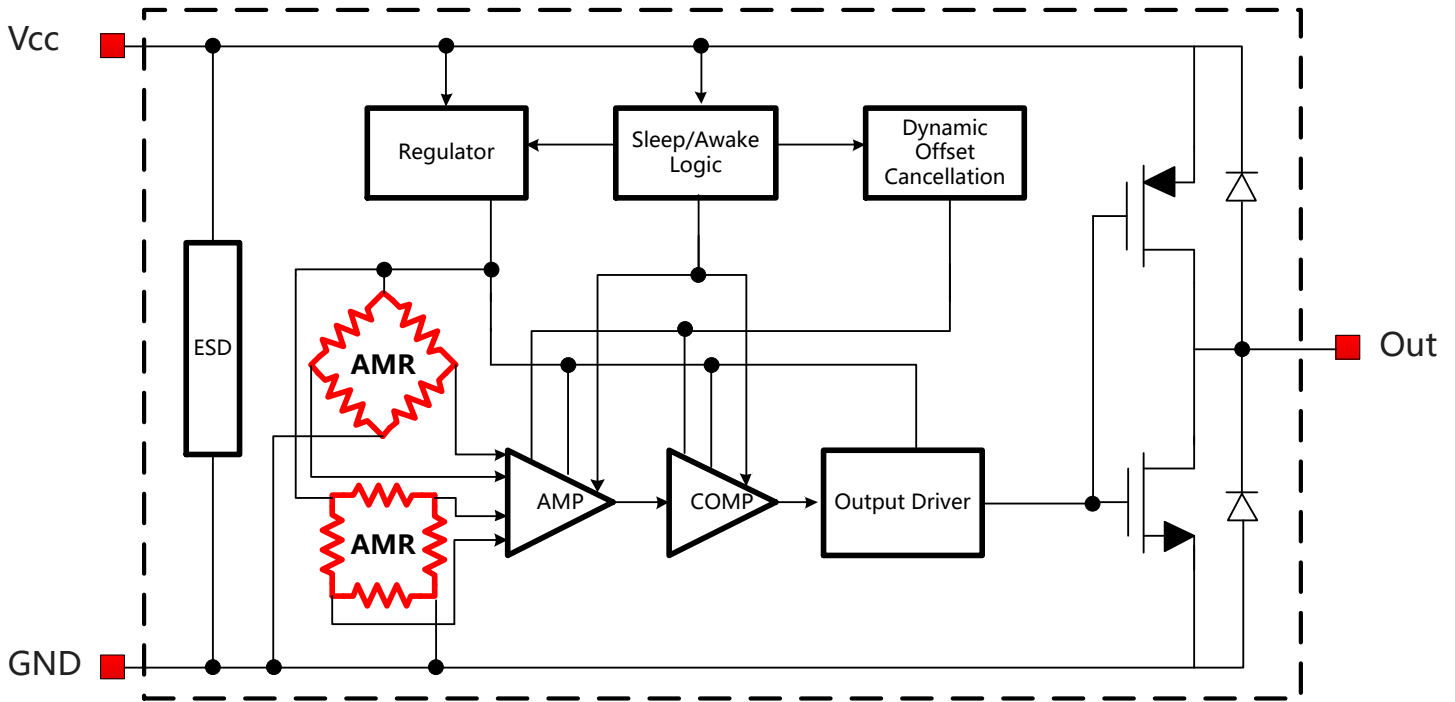

Figure.4 Functional Block Diagram (MT6131 & MT6132)

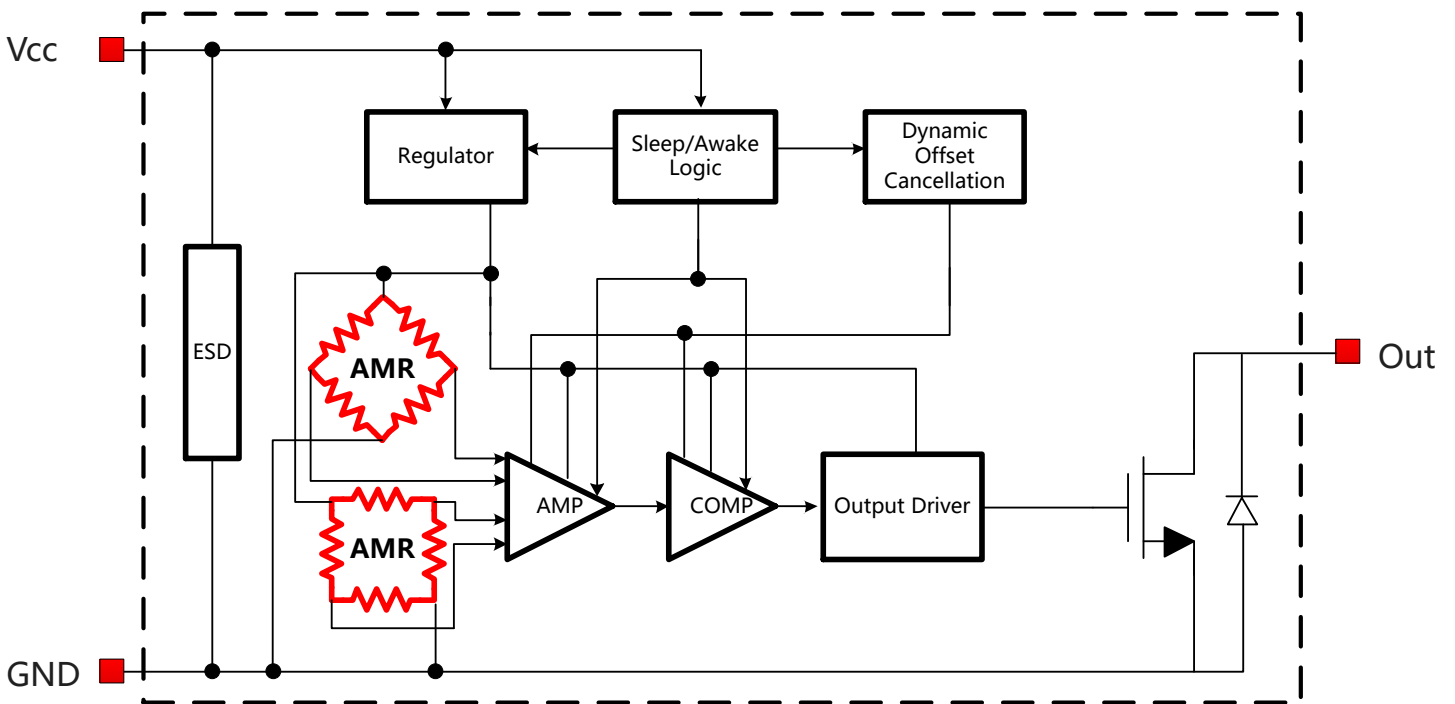

Figure.5 Functional Block Diagram (MT6133 & MT6135)

10 Electrical and Magnetic Characteristics

10.1 Absolute Maximum Ratings

Absolute maximum ratings are limited values to be applied individually, and beyond which the serviceability of the circuit may be impaired. Functional operability is not necessarily implied. Exposure to absolute maximum rating conditions for an extended period of time may affect device reliability.

| Symbol | Parameters | Min | Max | Units |
|------------------|-------------------------------|------|------|-------|
| V _{CC} | Supply Voltage | - | 7 | V |
| V _{RCC} | Reverse Battery Voltage | -0.4 | - | V |
| V _{OUT} | Output Voltage | - | 7 | V |
| I _{OUT} | Continuous Output Current | - | 20 | mA |
| T _A | Operating Ambient Temperature | -40 | 125 | °C |
| T _S | Storage Temperature | -50 | 150 | °C |
| T _J | Junction Temperature | - | 165 | °C |
| B | Magnetic Flux Density | | 1200 | Gs |

10.2 Electrical Specifications

At T_A=-40~125°C, V_{CC}=1.65V~5.0V (unless otherwise specified)

| Symbol | Parameters | Test Condition | Min | Typ | Max | Unit |
|------------------|------------------------------|---|------|------|------|------|
| V _{CC} | Supply Voltage | Operating | 1.65 | 3.60 | 5.00 | V |
| I _{CC} | Supply Current | MT6131 & MT6133, V _{CC} =3.6V, B < B _{RP} | - | 1.0 | 1.5 | uA |
| | | MT6132 & MT6135, V _{CC} =3.6V, B < B _{RP} | - | 11.0 | 15.0 | uA |
| V _{OH} | Output High Voltage | MT6131 & MT6132, V _{CC} =5V, I _{OUT} =5mA, B > B _{OP} | 4.6 | - | - | V |
| V _{OL} | Output Low Voltage | V _{CC} =5V, I _{OUT} =-5mA, B > B _{OP} | - | - | 0.4 | V |
| I _{OFF} | Output Leakage Current | V _{OUT} =5V, B < B _{RP} | - | - | 0.1 | uA |
| T _{PO} | Power on Time | dV _{CC} /dt > 3.6V/us, B > B _{OP} (MAX) | - | 80 | 120 | us |
| F _{OP} | Operation Frequency | MT6131 & MT6133, V _{CC} =3.6V | 10 | 20 | - | Hz |
| | | MT6132 & MT6135, V _{CC} =3.6V | 0.5K | 1K | - | Hz |
| T _{AW} | Awake Time | V _{CC} =3.6V | - | 16 | - | us |
| T _{SL} | Sleep Time | MT6131 & MT6133, V _{CC} =3.6V | - | 50 | - | ms |
| | | MT6132 & MT6135, V _{CC} =3.6V | - | 1 | - | ms |
| D.C. | Duty Cycle | MT6131 & MT6133, V _{CC} =3.6V | - | 0.03 | - | % |
| | | MT6132 & MT6135, V _{CC} =3.6V | - | 1.50 | - | % |
| R _{TH} | Thermal Resistance of SOT-23 | | - | 301 | - | °C/W |

10.3 Magnetic Characteristics

At $T_A = 25^\circ\text{C}$, $V_{CC} = 1.65\text{V} \sim 5.0\text{V}$ (unless otherwise specified)

| Part No. | Symbol | Min | Typ | Max | Unit |
|---------------|--------|---------|----------|----------|------|
| MT613X Series | BOP | - | ± 18 | ± 28 | Gs |
| | BRP | ± 3 | ± 13 | - | Gs |
| | BHYST | - | 5 | - | Gs |

10.4 ESD Ratings

| Symbol | Reference | Values | Unit | |
|-----------|----------------------------|--------------|------|---|
| V_{ESD} | Human-body model (HBM) | AEC-Q100-002 | 4000 | V |
| | Charged-device model (CDM) | AEC-Q100-011 | 1000 | V |

10.5 Characteristic Performance

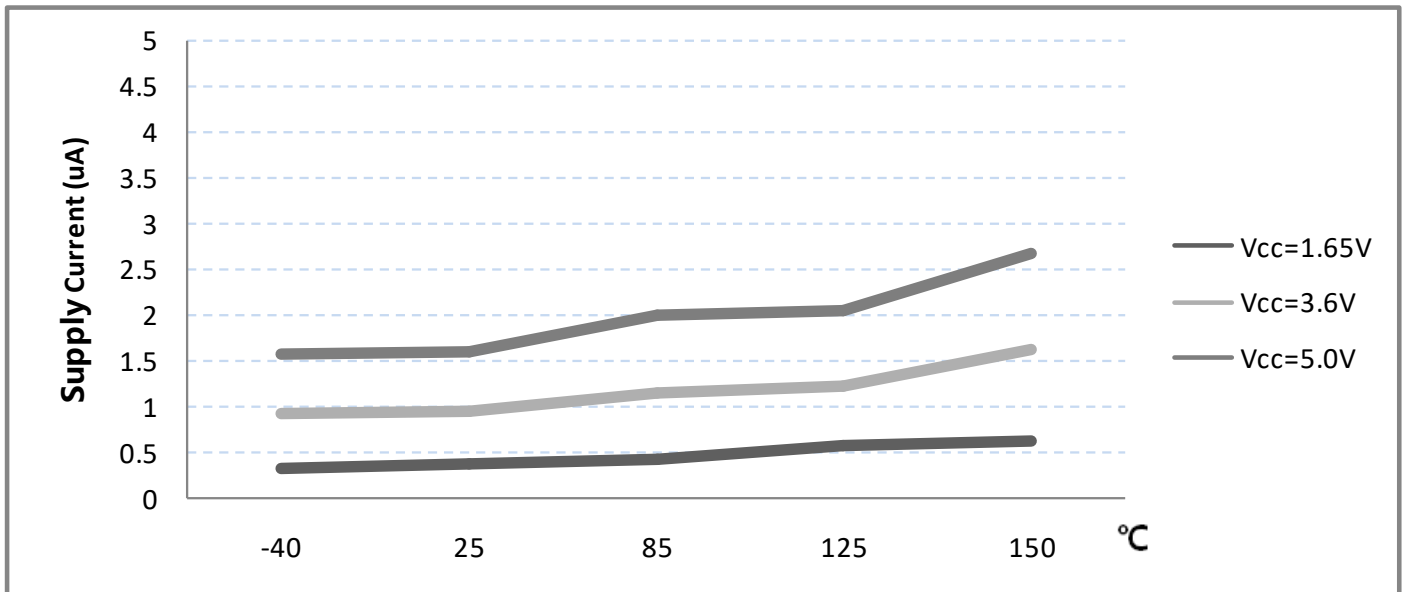

Figure.6 Supply Current vs. Temperature

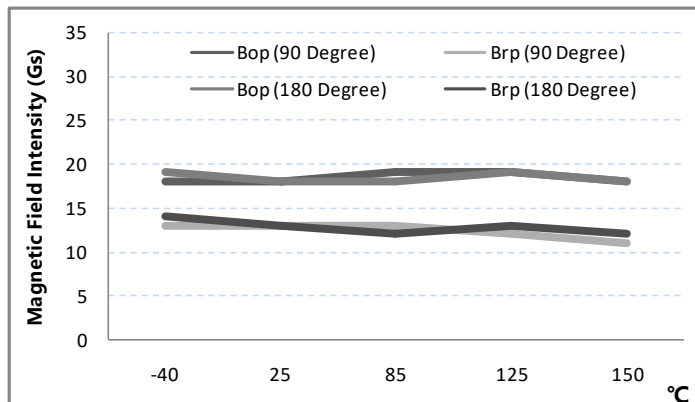

Figure.7 Magnetic Characteristics vs. Temperature (BOP & BRP) (At $V_{CC} = 3.6\text{V}$)
Magnetic Field @ 90 Degree & 180 Degree

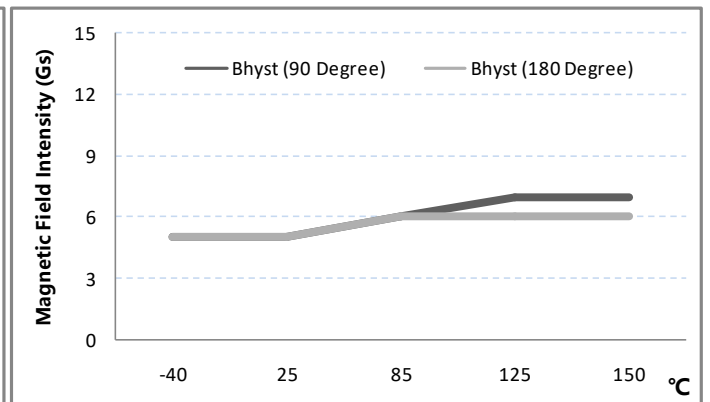

Figure.8 Magnetic Characteristics vs. Temperature (BHYST) (At $V_{CC} = 3.6\text{V}$)
Magnetic Field @ 90 Degree & 180 Degree

10.5 Characteristic Performance (continued)

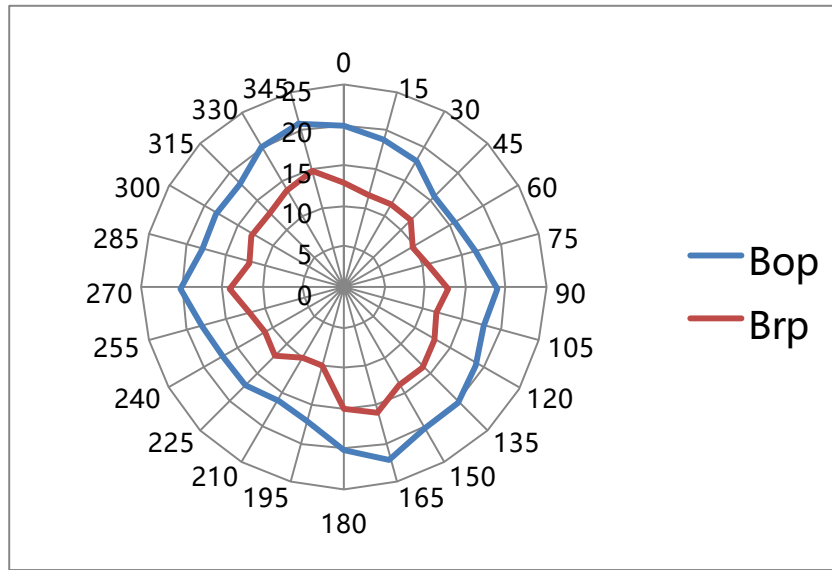
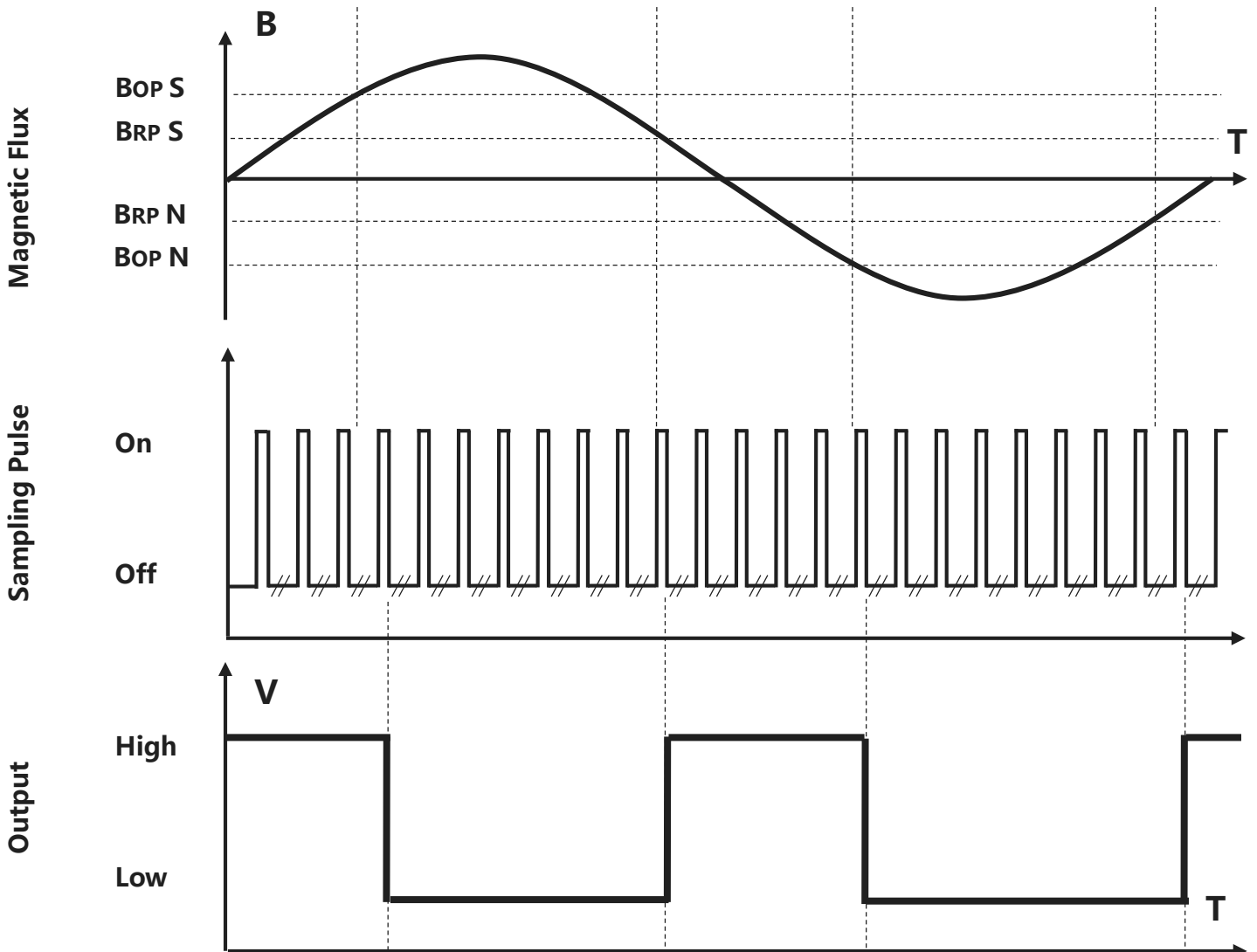

Figure.9 360 Degree Magnetic Characteristics (At Vcc=3.6V, TA=25 °C)

10.6 Typical Output Waveform

MT6131AT as example



Note: Output is not immediately updated until the chip wakes up from sleep mode and samples the input

Figure.10 Digital Output vs. Magnetic Flux Density & Sampling Pulse

11 Typical Application Circuit

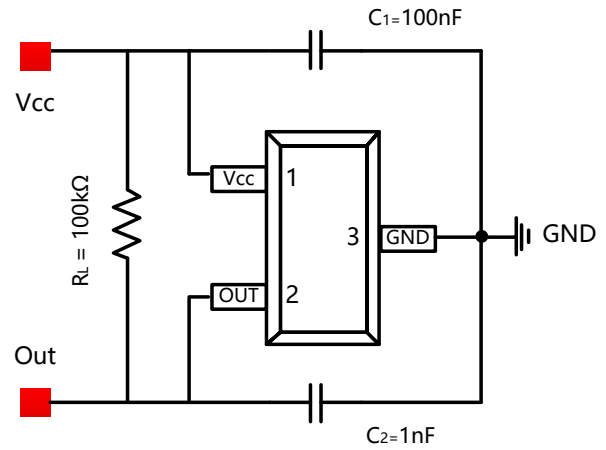
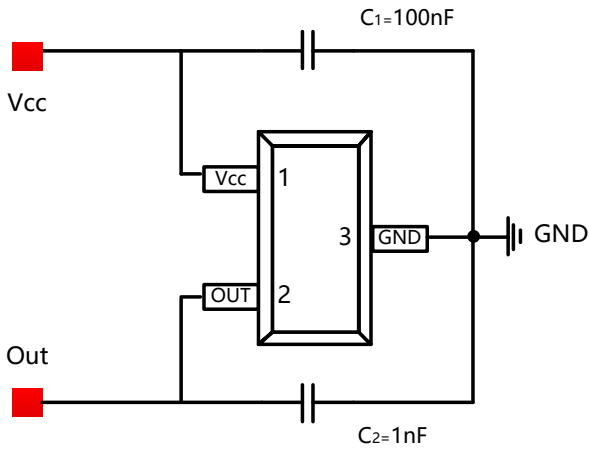

Figure.11 Typical Application Circuit
Push Pull Output
MT6131 & MT 6132

Figure.12 Typical Application Circuit
Open Drain Output
MT6133 & MT 6135

12 Power on Output Waveform

V_{CC} rise time $< 1\mu s$, T_{PO} is the time from the stable point of V_{CC} to the valid point of output

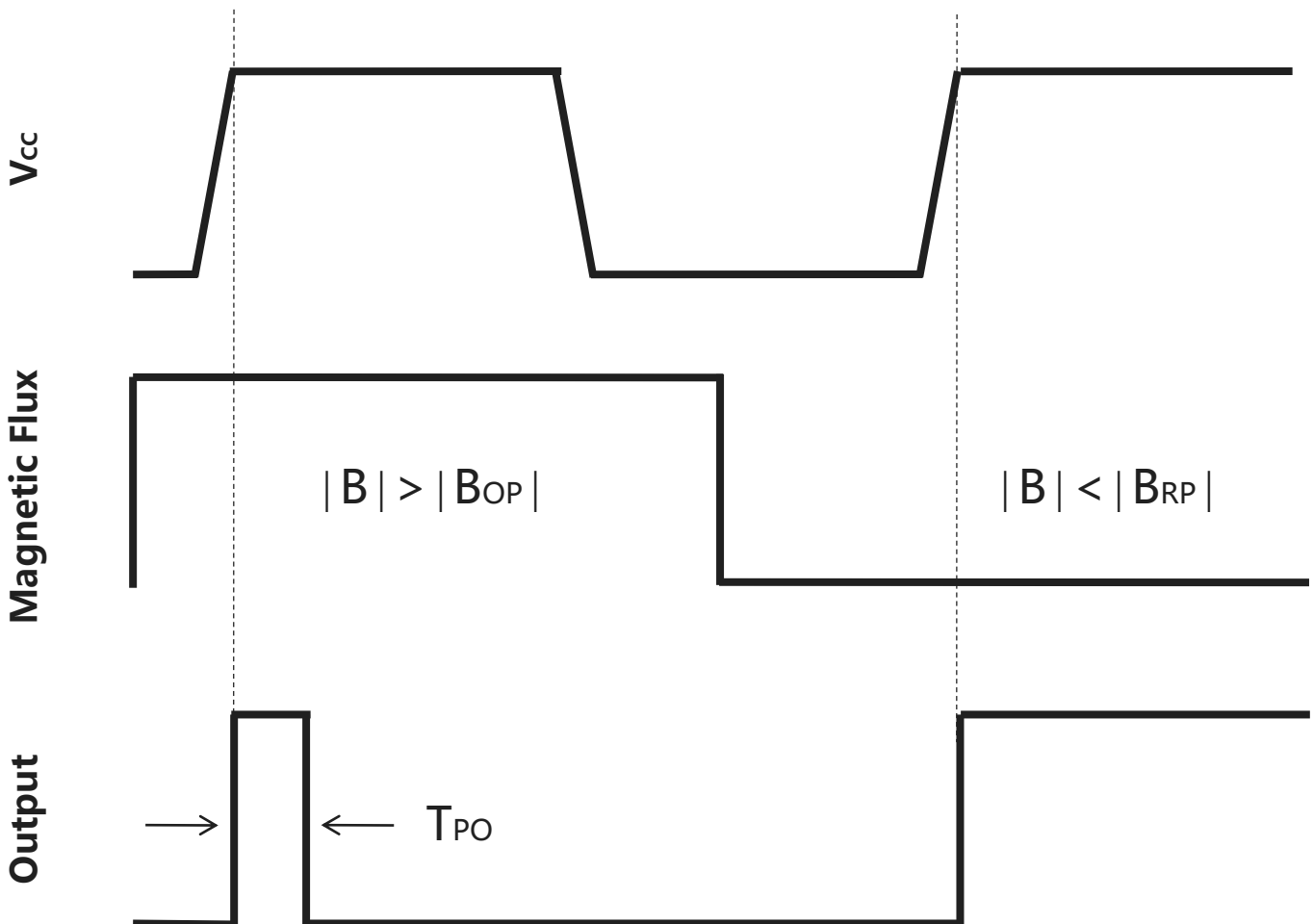

Figure.13 Power on Output Waveform

13 Package Material Information (For Reference Only – Not for Tooling Use)

13.1 SOT-23 Package Information

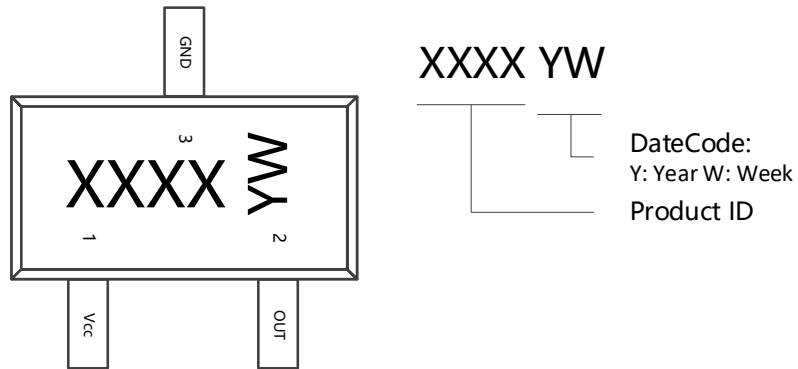

Figure.14 SOT-23 Chip Marking Spec

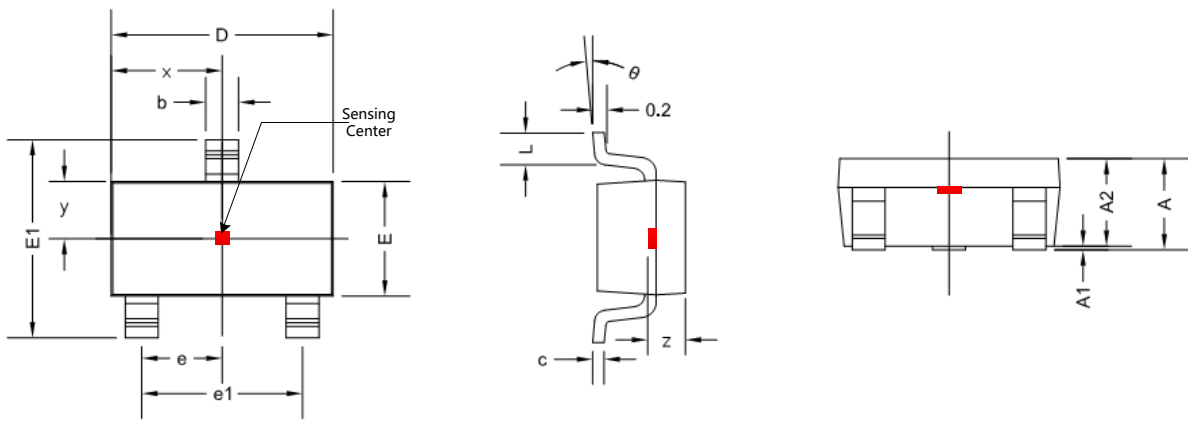

Figure.15 SOT-23 Package Drawing

| Symbol | Dimensions in Millimeters | | Dimensions in Inches | |
|--------|---------------------------|-------|----------------------|-------|
| | Min | Max | Min | Max |
| A | 1.050 | 1.250 | 0.041 | 0.049 |
| A1 | 0.000 | 0.100 | 0.000 | 0.004 |
| A2 | 1.050 | 1.150 | 0.041 | 0.045 |
| b | 0.300 | 0.500 | 0.012 | 0.020 |
| c | 0.100 | 0.200 | 0.004 | 0.008 |
| D | 2.820 | 3.020 | 0.111 | 0.119 |
| E | 1.500 | 1.700 | 0.059 | 0.067 |
| E1 | 2.650 | 2.950 | 0.104 | 0.116 |
| e | 0.950 TYP | | 0.037 TYP | |
| e1 | 1.800 | 2.000 | 0.071 | 0.079 |
| L | 0.300 | 0.600 | 0.012 | 0.024 |
| θ | 0 ° | 8 ° | 0 ° | 8 ° |
| x | 1.460 TYP | | 0.057 TYP | |
| y | 0.800 TYP | | 0.032 TYP | |
| z | 0.600 TYP | | 0.024 TYP | |

14 Copy Rights and Disclaimer

1. This document may not be reproduced or duplicated, in any form, in whole or in part without prior written consent of MagnTek . Copyrights © 2019, MagnTek Incorporated.
2. MagnTek reserves the right to make changes to the information published in this document at anytime without notice.
3. MagnTek' s products are limited for use in normal commercial applications. MagnTek' s products are not to be used in any device or system, including but not limited to medical life support equipment and system.

For the latest version of this document, please visit our website: www.magntek.com.cn